

# 360 IQ CAP PRESS™

## OPERATOR'S MANUAL



STAHL'S  
**Hotronix®**

**When using your heat press, basic precautions should always be followed, including the following:**

1. Read all instructions.
2. Use heat press only for its intended use.
3. To reduce the risk of electric shock, do not immerse the heat press in water or other liquids.
4. Never pull cord to disconnect from outlet, instead grasp plug and pull to disconnect.
5. Do not allow cord to touch hot surfaces, allow heat press to cool completely before storing.
6. Do not operate heat press with a damaged cord or if the equipment has been dropped or damaged. To reduce the risk of electric shock, do not disassemble or attempt to repair the heat press. Take it to a qualified service person for examination and repair. Incorrect assembly or repair could increase the risk of fire, electric shock, or injury to persons when the equipment is used. Power supply cord must be disconnected before cleaning or servicing press.
7. This appliance is not intended for use by persons (including children) with reduced physical, sensory or mental capabilities, or lack of experience and knowledge, unless they have been given supervision or instruction concerning use of the appliance by a person responsible for their safety.
8. Close supervision is necessary for any heat press being used by or near children. Do not leave equipment unattended while connected.
9. To avoid burns, do not touch hot metal parts or the heated platen during use.
10. To reduce the likelihood of circuit overload, do not operate other high voltage equipment on the same circuit.
11. If an extension cord is necessary, then a 20-ampere rated cord should be used. Cords rated for less ampere may overheat. Care should be taken to arrange the cord so that it cannot be pulled or tripped over.
12. Keep hands clear of the upper heat press platen during lock down as the pressure may cause injury.
13. Heat press should be placed on a sturdy, suitable stand at least 36"L x 24"W x 29"H.
14. Work area must be kept clean, tidy and free of obstructions.

# Table Of Contents

**Safety Instructions** 2

**Machine View** 4

**Operating Instructions** 5-7

Connecting the System 5

Start Up/Shut Down 5

Home Screen 6

Prepare to Print 7

**Touch Screen Guide** 8-11

Setup Menu 8

Password Setup 8

Preset Setup 9

Date & Time Setup 10

Display Setup 10

Auto On & Off Setup 10

System Setup 10

Calibration 11

Updating Software 11

**Connect to the IQ™ Portal** 12

**Electrical Schematic** 13

**Replacement Parts List** 14-15

**Contact** 16

# HOTRONIX® 360 IQ CAP PRESS™

## Machine View





# Operating Instructions

## Connecting the System

Insert power cord into IEC inlet located on the side of press (1.1).

Connect the power cord into a properly grounded electrical outlet with a sufficient amperage rating.

To remove a locking power cord (if equipped), depress the two red buttons while pulling on the plug (1.2).



1.1

### Voltage

**120 volt** presses require a full 10 amp grounded circuit.

**240 volt** presses require a full 5 amp grounded circuit.

### Extension Cords

If used, extension cords should be as short as possible and not less than 12 gauge. Heavy duty cords are recommended.

### Circuits

Circuits that have less than 10 amps, or have other high demand equipment or appliances (especially more than one heat press) plugged in, should not be used.

**Note:** If supply cord is damaged, it must be replaced by the manufacturer, its service agent, or a similarly qualified person to avoid hazard. Use SJT type rated 300 V cord for replacement.



1.2

## Start Up/Shut Down

Locate the packaging bolt on top of press and remove prior to turning on or operating (2.1).

To start up your heat press: Flip the power switch ON (2.2). A splash screen displaying the Hotronix® logo and current software version is shown for several seconds.

To turn your heat press off, flip the power switch OFF.

To place your heat press into Standby Mode, touch and release the Power icon on the Home Screen (3.2 - following page). In Standby Mode, the heater turns off while the Touch Screen remains on, displaying an orange background as a warning if the platen is still hot (above 100°F / 38°C).

**NOTE:** Standby Mode must be used for the Auto On feature to function (10.1). The Auto On feature will not work if the power switch (2.1) is in the OFF position.

To start up your heat press while in Standby Mode, touch and release the Home icon on the Standby Screen.



2.1



2.2

## Home Screen

Status bar provides helpful information regarding heat press.

Touch and edit your favorite presets.

Lock the screen (Manager-level only) to prevent User-level operators from changing settings.

Touch and edit Users to control operator access level and track press usage by operator in the IQ™ Portal.

Touch Setup Menu.

Place press in Standby Mode to take advantage of the scheduled Auto On feature.

Displays current top heater temperature

Displays current bottom heater temperature

Displays current application pressure and time.

IQ™ Portal and WIFI connection status.

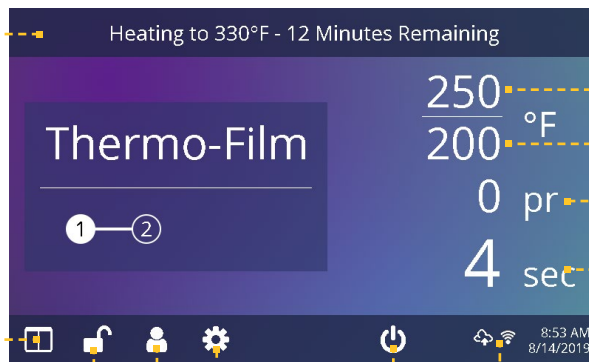

3.1

Displays the selected preset. Touch and hold to see application settings.

**NOTE:** Holding down material name will display targeted application settings. Screen displays current temperature, pressure, and time.

Displays multiple heat application preset step. Touch the empty circled numbers to switch between preset steps.

Tap any print parameter to adjust its target value.

Tap a section of the top bar to quickly jump to the corresponding value

Tap up/down arrows for fine adjustment of target value

Tap check mark to accept new value or X to cancel

Tap "Off" to disable heater

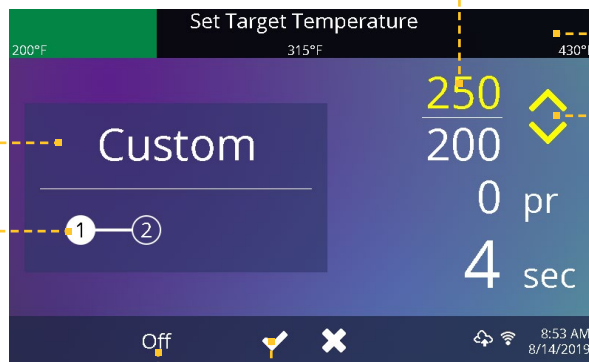

3.2

# Preparing to Print

Before heat applying, set the target settings for the selected transfer material by:

- Selecting a Preset (7.1), or
- Manually entering target temperature, time and pressure.

Temperature and time are controlled automatically. Pressure must be set manually:

- Position a cap on the lower heater (4.1)
- Lower the cap hold down lever (4.2) to lock it in place
- Enable “Target Temp” option in System Settings (11.1) to prevent the electromagnet from locking down until Target Temperature is reached
- Pull lift handle down and observe the pressure reading
- Adjust the pressure by turning the Pressure Adjustment Knob

A visual Pressure Readout is located on the Home Screen. When the handle is locked into the PRINT position, a pressure number between 0-9 will be displayed.

- 0 = No pressure
- 1 - 3 = Light Pressure
- 4 - 7 = Medium Pressure
- 8 - 9 = Heavy Pressure

**WARNING:** Structural damage caused by excessive pressure is not covered under the limited warranty!

The lower heater alignment can be adjusted by loosening the knob to accommodate different cap sizes (4.3).

Once your equipment has reached the designated temperature:

- Position the cap and design (4.1)
- Lower the cap hold down lever to lock cap into place (4.2)
- Pull lift handle down and begin to heat apply
- The automatic timing process will begin
- The Home Screen will initiate a count down and lift the heat platen into the UP position when the print cycle is complete (4.4).



4.1



4.2



4.3



4.4

### Setup Menu

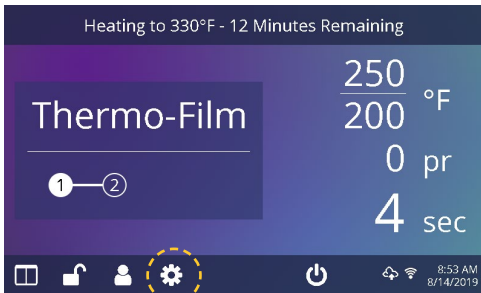

5.1

Touch the Settings icon on the Home Screen (5.1) to configure your heat press.

Managers can access all setup options, while Users can access a limited set (5.2).

- Managers default password: M

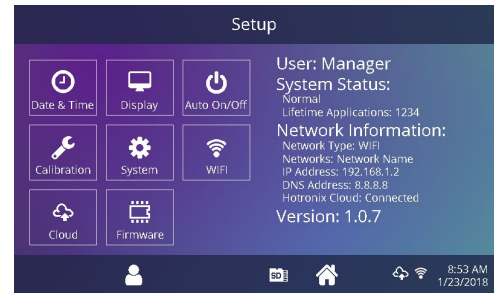

5.2

### Password Setup (Manager Level Only)

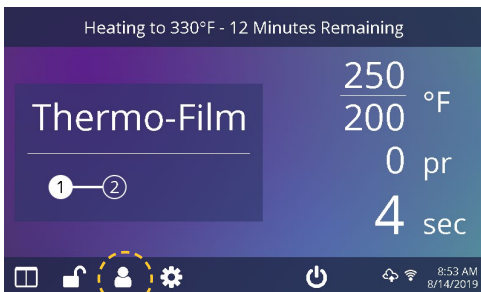

6.1

Touch the User icon on the Home Screen (6.1) or Setup Menu (6.2) to select, add, and edit Users.

Touch and edit Managers and Users to configure access to settings (6.3, 6.4). Heat press reports on the IQ™ Portal can be filtered by User to track individual operator performance.

Touch the arrow keys on the taskbar to scroll through a long list of Users (6.5).

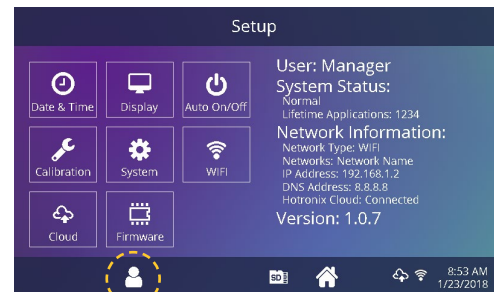

6.2

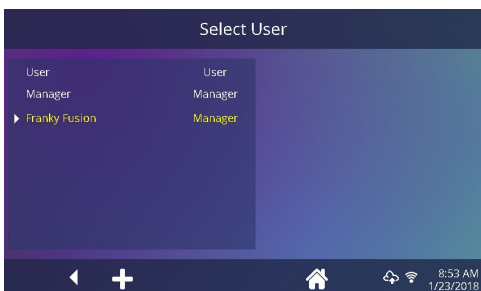

6.3

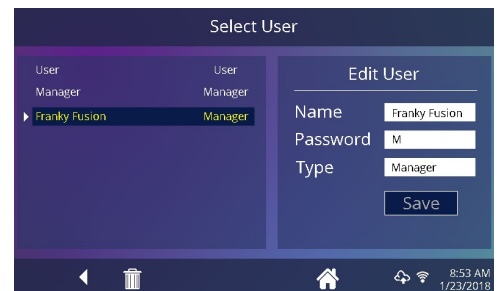

6.4

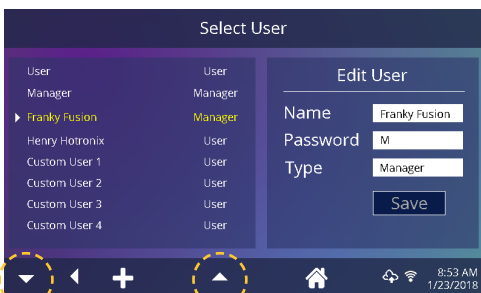

6.5



# Preset Setup

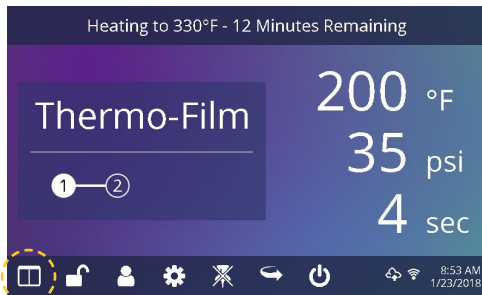

7.1

Touch the Columns icon (7.1) to select from a list of saved presets (7.2).

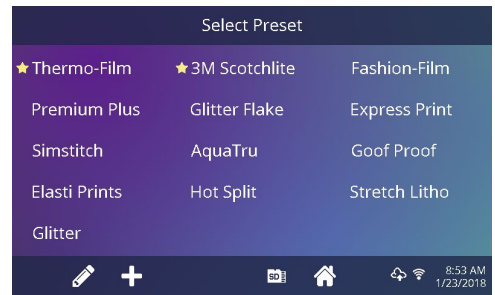

7.2

Touch the arrow keys on the taskbar to scroll through a long list of presets (7.3).

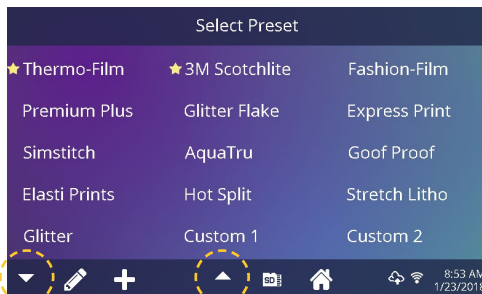

7.3

Touch a preset to select a material.

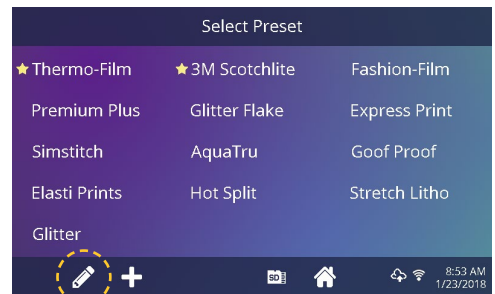

7.4

Touch the Pencil icon (7.4) to enter edit mode, then touch preset name to edit settings. Touch Save to save changes.

Touch the Plus icon to create a new preset (7.5).

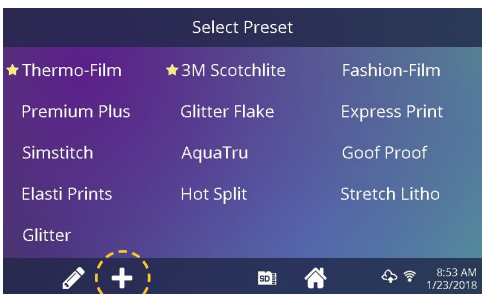

7.5

Name your preset and enter desired temperatures, time, and pressure. When creating a new preset, the current Home Screen application settings are selected automatically (7.6).

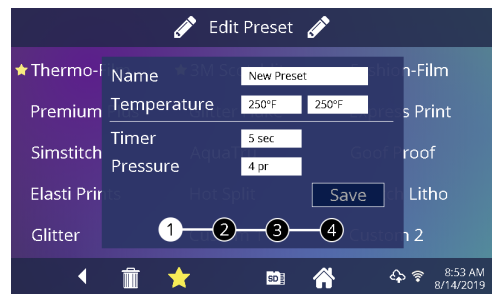

7.6

Touch the empty circled numbers to set multiple preset stages for pretreatment or multi-step applications (7.7).



7.7

### Date & Time Setup

Touch the Settings icon on the Home Screen.

- Touch Date & Time, information displays on right of screen (8.1).
- Touch up/down arrows to select time zone.
- Touch Auto to automatically synchronize the heat press clock. The heat press must be connected to a WIFI network with access to the Internet.
- Touch Daylight Saving to enable daylight saving mode. This option should be enabled during summer.

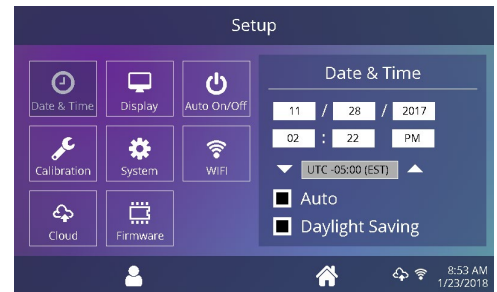

8.1

### Display Setup

Touch the Settings icon on the Home Screen.

- Touch Display, information displays on right of screen (9.1).
- Touch Temperature to switch between F° or C°, then touch Check Mark icon on taskbar to save.

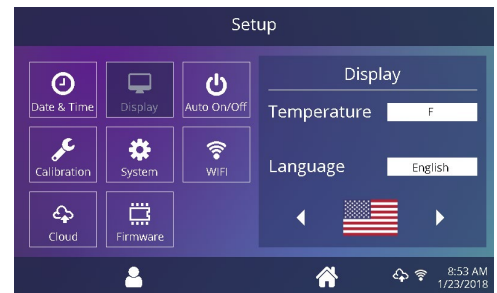

9.1

### Auto On & Off Setup

Touch the Settings icon on the Home Screen.

- Touch Auto On/Off, information displays on right of screen (10.1).
- Touch Enable, then On Hour/Minute and Off Hour/Minute, selecting Enter between each setting. Once entered, touch Check Mark icon on taskbar to save.

**NOTE:** Standby Mode must be used for the Auto On feature to function (3.2). The Auto On feature will not work if the power switch (2.1) is in the OFF position.

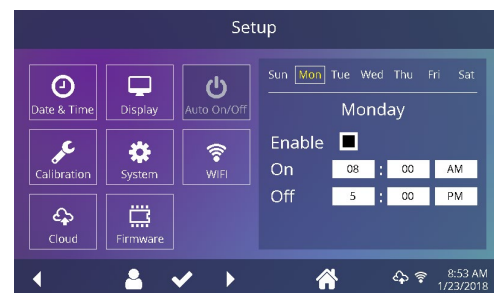

10.1

### System Setup (Manager Level Only)

Touch the Settings icon on the Home Screen.

- Select System, information displays on right of screen (11.1).
- Touch Power Save and select time, then touch Check Mark icon on taskbar to save. When enabled, your heat press will enter Standby Mode if it is not used for the specified number of hours.
- Touch Target Temp to prevent the electromagnet from activating until target temperature is reached.

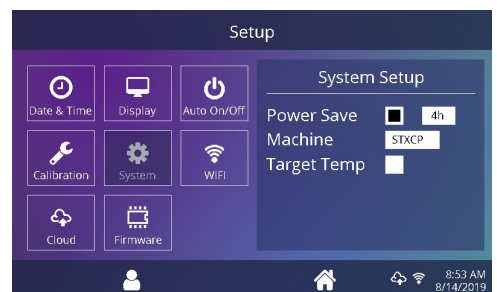

11.1

## Calibration (Manager-Level Only)

Your heat press comes pre-calibrated from the factory. Calibration is only required after sensor or controller replacement. Pressure is periodically self-calibrated. Incorrect calibration can result in poor print results or damage to your heat press which is not covered by warranty.

Your heat press has a temperature calibration function (12.1).

- Turn on heat press and heat to 350°F/177°C.
- Measure center of heater with contact thermocouple (not infrared) thermometer.
- Touch the Settings icon on the Home Screen.
- Touch Calibration, information displays on right of screen.
- Touch Temperature 1 for the top heater and adjust Temperature Calibration to match Target Temperature.
- Touch Temperature 2 for the bottom heater and adjust Temperature Calibration to match Target Temperature. Remove rubber cap and adjust 100°F below measured temperature for best results.

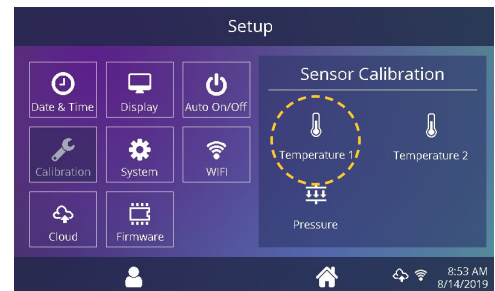

12.1

Your heat press has a pressure calibration function (12.2).

- Touch the Settings icon on the Home Screen.
- Touch Calibration, information displays on the right of screen.
- Touch Pressure and then Calibrate. Wait for the screen to display 2.5V.
- Turn Adjustment Knob counterclockwise (reducing pressure) until stop
- Place one thin (1/8" 3mm) white pad on mandrell, lower print handle and secure to electromagnet using 1/4"-20 x 3/4" screw.
- Tap Set Min Point (screen should display reading of approximately 2.5V)
- Unscrew and raise print handle.
- Place two additional thick (3/8" 10mm) white pads on mandrell (7/8" 22mm total), lower print handle and secure to electromagnet using 1/4"-20 x 3/4" screw
- Tap Set Max Point (screen should display reading around 2.1V to 2.4V)
- Unscrew and raise print handle.

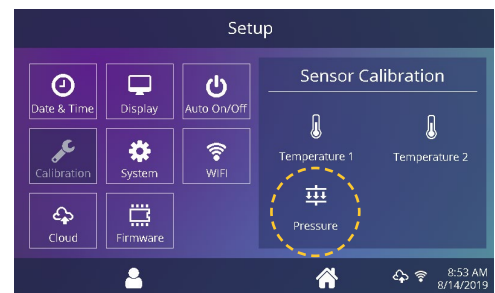

12.2

## Updating Software

Touch the Settings icon on the Home Screen.

- When a software update is available, an exclamation point appears after the version number in the Setup Menu (5.2).
- Touch Firmware, information displays on right of screen. An available online update displays a cloud icon (12.2).
- Touch Update File on right of screen, then touch Check Mark icon on taskbar to start download. A downloaded update displays a memory card icon.
- Touch Downloaded Update File on right of screen, then touch Check Mark icon on taskbar to start installation.

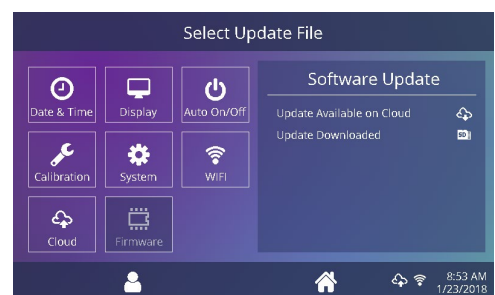

12.3

**NOTE:** If a power failure occurs during installation, the heat press will attempt to install the previous software version.

# HOTRONIX® 360 IQ CAP PRESS™

## Connect to the IQ™ Portal

### Create Your Account

- Using a phone or computer, visit [iq.hotronix.com](http://iq.hotronix.com) to create an account (13.1).
- Enter your name, email, and password.
- Click on the confirmation link in the email you receive.
- Your account has been created.

### Register a Heat Press

- Click on Manage Heat Presses, then New Heat Press.
- Select heat press type, enter serial number, and enter a name for the heat press (optional).
- Click on Create Heat Press and enter the verification code given.
- On the heat press Setup Menu, touch WIFI and connect to your WIFI router or mobile hotspot (13.2).
- On the heat press Setup Menu, touch the Cloud icon and enter the verification code displayed in the IQ™ Portal (13.3).
- Your heat press has been registered.

### Create & Assign Users

- Click on Manage Operators, then New User.
- Enter a name and select a privilege level. Managers can access all heat press settings while Users have limited access.
- Click on New User, then Assign Machines in the sidebar.
- Select a machine and click Assign.
- On the heat press Setup Menu, touch the Cloud icon, then Manual Sync (13.4).
- Reporting will show impressions made by the Users.

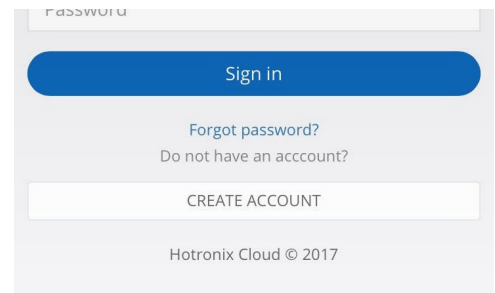

13.1



13.2

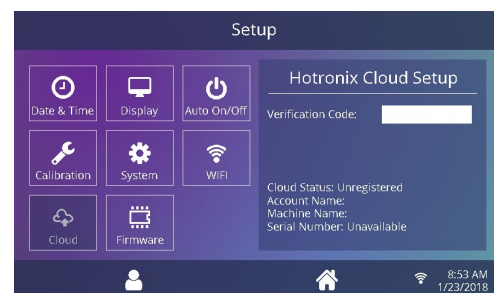

13.3

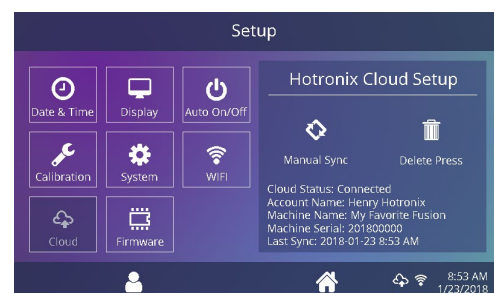

13.4



# Electrical Schematic

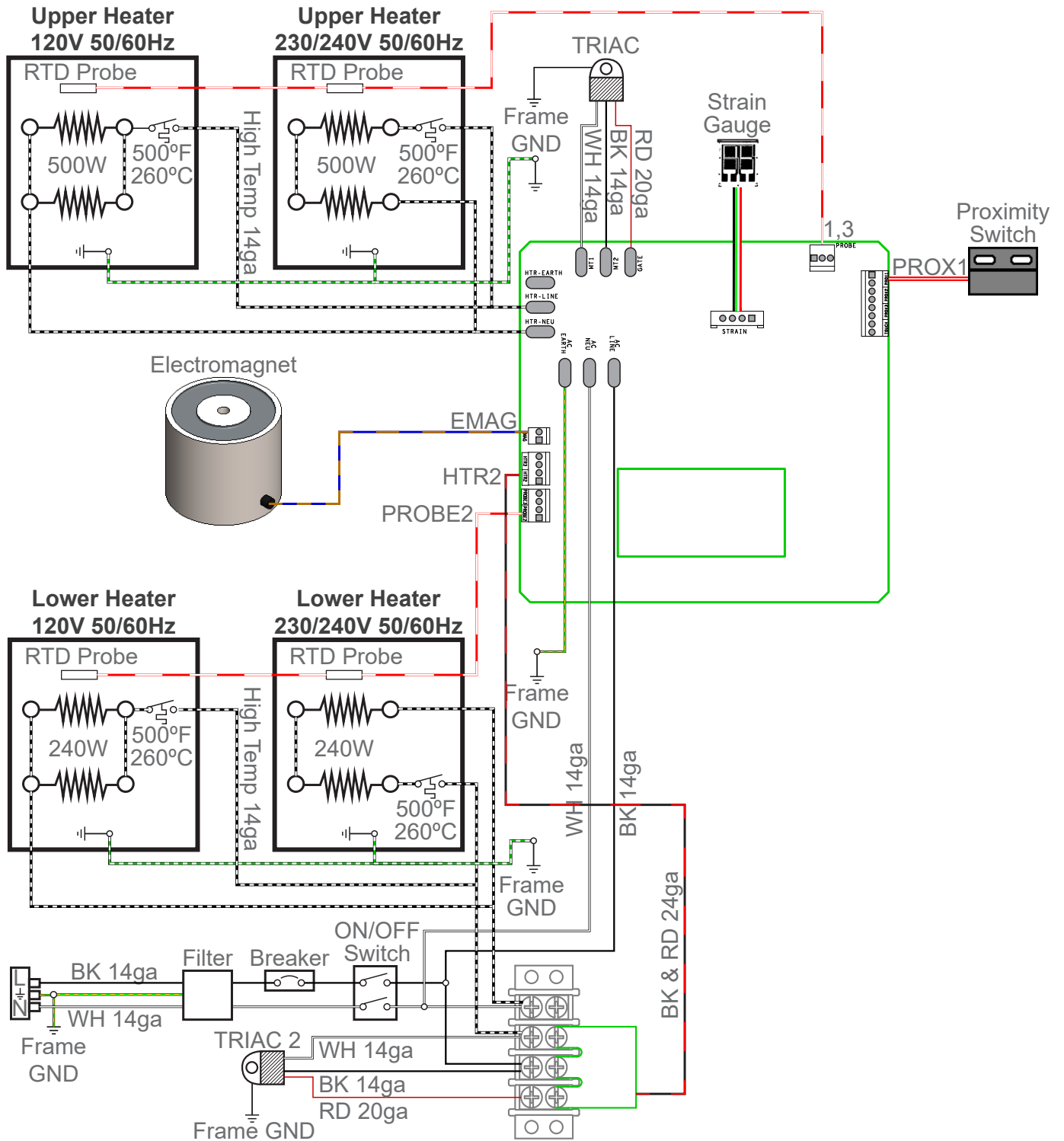

# HOTRONIX® 360 IQ CAP PRESS™

## Replacement Parts List

#	PART#	DESCRIPTION	QTY.
1	4-1183	Heater Arm, 360 IQ Hat	1
2	2-1055-11	Steel Pin, 1/2" x 5-9/16"	1
3	1-1107-1	Hub Cap 1/2"	2
4	1-1048-3	Washer, 1/2" Nylon	14
5	-	Cord Grip, Sure Clamp Submersible	2
6	-	Threaded Insert, 1"-8 to 5/8"-11	1
7	-	Heater Arm Panel, Rear	1
8	-	Heater Arm Panel, Front	1
9	1-1945-1	Electromagnet	1
10	1-2133	Silicone Pad, 5/16" ID x 1-3/4" OD x 1/4" T	1
11	-	PVC Spacer, 1/2" x 4-3/8"	1
12	-	Standoff, #6-32, 3/8" OD, 3/8" Long	2
13	1-1219	Proximity Magnet	1
14	3-1011-10	Screw, Machine #8-32 x 1/4"	7
15	-	Screw, #6-32 x 3/8", Stainless	4
16	-	Lockwasher, #6 External-Tooth Stainless	2
17	-	Steel Pin, 1/2" x 8-3/32"	1
18	3-1011-233	Screw, Shoulder 5/16" x 1/2"	1
19	-	Steel Pin, 1/2" x 7-9/16"	1
20	-	Handle Weldment, 360 IQ Hat	1
21	-	Shaft Collar, 1/2" One-Piece Clamp-On	4
22	-	Link Weldment, 360 IQ Hat	2
23	-	Shaft Collar, 1/2" One-Piece (Modified)	2
24	-	Threaded Rod, 1/4"-20 x 6"	1
25	2-1006-2	JCN - NUT	2
26	-	PVC Spacer 1" x 6"	1
27	-	Magnet Plate, 360 IQ Hat	1
28	1-1540	Foam Grip, Black	1
29	3-1011-127	Screw, Machine #8-32 x 3/8" Black Oxide	15
30	3-1386	Heater, Upper, 360 IQ Hat, 500W	1
31	1-2076	Thermostat Disc	2
32	2-2147	Adjustment Spindle, Cap	1
33	1-1095	Knob, Black Plastic 3/8"-16	1
34	3-1011-238	Bolt, Hex Head 5/16-18 x 3-1/2"	1
35	1-2163	Compression Spring	1
36	-	Silicone Cap, 1/2" x 1"	1
37	3-1011-98	Screw, SS Sheet Metal #4 X 1/4"	4
38	1-1272-1	Temperature Probe	2
39	3-1385	Heater, Lower, 360 IQ Hat 240W	1
40	-	Insulation, 1/8" x 2.75" x 5.75"	1
41	2-1006-101	Washer, #6 Oversized	1
42	-	Screw, #4-40 x 3/8" Stainless	1
43	-	Weld Nut, 1/4"-20 Steel	1
44	-	Screw, #8-32 x 1/2" Stainless	5
45	-	Lock Washer, #8 External Tooth	1
46	-	Dowel Pin, 1/4" x 3/4" Pull-Out	1
47	-	Clamp Handle, 1/4"-20 x 1-3/4" Long	1
48	1-2592	Thermal Snap Cap	1
49	-	Lower Heater Plate, 360 IQ Hat	1
50	-	Spacer, Steel, 1/2" OD, 1/8" LG, 1/4" Screw	1

#	PART#	DESCRIPTION	QTY.
51	2-1006-46	Washer, 5/16" SS	1
52	4-1179	Lower Frame, 360 IQ Hat	1
53	4-1180	Cap Hold Down, 360 IQ Hat	1
54	-	Nut, #8-32 Cap Stainless	1
55	1-1073	Spring	1
56	-	Round Rubber Grip, 3/4" x 4-1/2"	1
57	-	Loop Clamp, 3/8" Galv Steel	1
58	-	Cable Holder, Nylon Self-Adhesive	1
59	-	Lower Support Cover, 360 IQ Hat	1
60	1-2463	Fusion IQ Controller	1
61	1-2463-P	Fusion IQ Power Board	1
62	1-2473	Fusion IQ Power Bracket	1
63	1-2474	Fusion IQ Latch	2
64	1-2485	Spring, 1/4" x 1", 1.7lbs/in	2
65	3-1011-235	Screw, #6 x 1/2" for Plastic	4
66	-	Spacer, 1/4" x 1/4" Slotted	2
67	-	Washer, #8 Stainless	2
68	-	Screw, #8-32 x 1/2" Stainless	1
69	-	Silicone Pad, 1/4" x 1" Self-Adhesive	2
70	3-1011-25	Screw, Machine #6-32 x 1/4"	6
71	1-2386	Touchscreen Stylus Holder	1
72	1-2385	Touchscreen Stylus	1
73	-	Base Plate, 360 IQ Hat	1
74	1-2575	Rubber Foot	4
75	4-1181	Base Channel, 360 IQ Hat	1
76	-	Nut, M8x1.25 Cap	4
77	3-1011-243	Screw, Socket Head 1/4"-20 x 3/4"	8
78	3-1011-100	Screw, Socket Head 5/16"-18 x 3/4"	8
79	2-1006-44	Washer, Split Lock 1/4"	8
80	2-1006-86	Washer, Split Lock 5/16"	8
81	1-1059	TRIAC	2
82	-	TRIAC Driver Board	1
83	-	Gas Spring 20lbs	2
84	4-1182	Column, 360 IQ Hat	1
85	1-1759	Power Inlet	1
86	1-1331	Circuit Breaker 20A (STX XF XRF)	1
87	-	Column Back Plate, 360 IQ Hat	1
88	-	Proxy Plate, 360 IQ Hat	1
89	1-2087	Power Switch	1
90	1-1211	Proximity Switch	1
91	3-1011-22	Screw, Machine #4-40 x 3/8"	2
92	2-1006-51	Nut, #4-40 with Tooth Washer	2
93	3-1011-19	Screw, Machine #6-32 x 1/2"	6
94	2-1006-50	Nut, #6-32 Hex with Lockwasher	2
95	-	Set Screw, 5/16"-18 x 1/2"	1
96	-	Set Screw, 5/16"-18 x 3/4"	1
97	-	Filter, Schaffner FN2090-6-06	1
98	-	Ferrite Core 461167281	1
99	-	Conduit	1
100	2-1671	120V Locking Power Cord	1

# Parts Location Guide

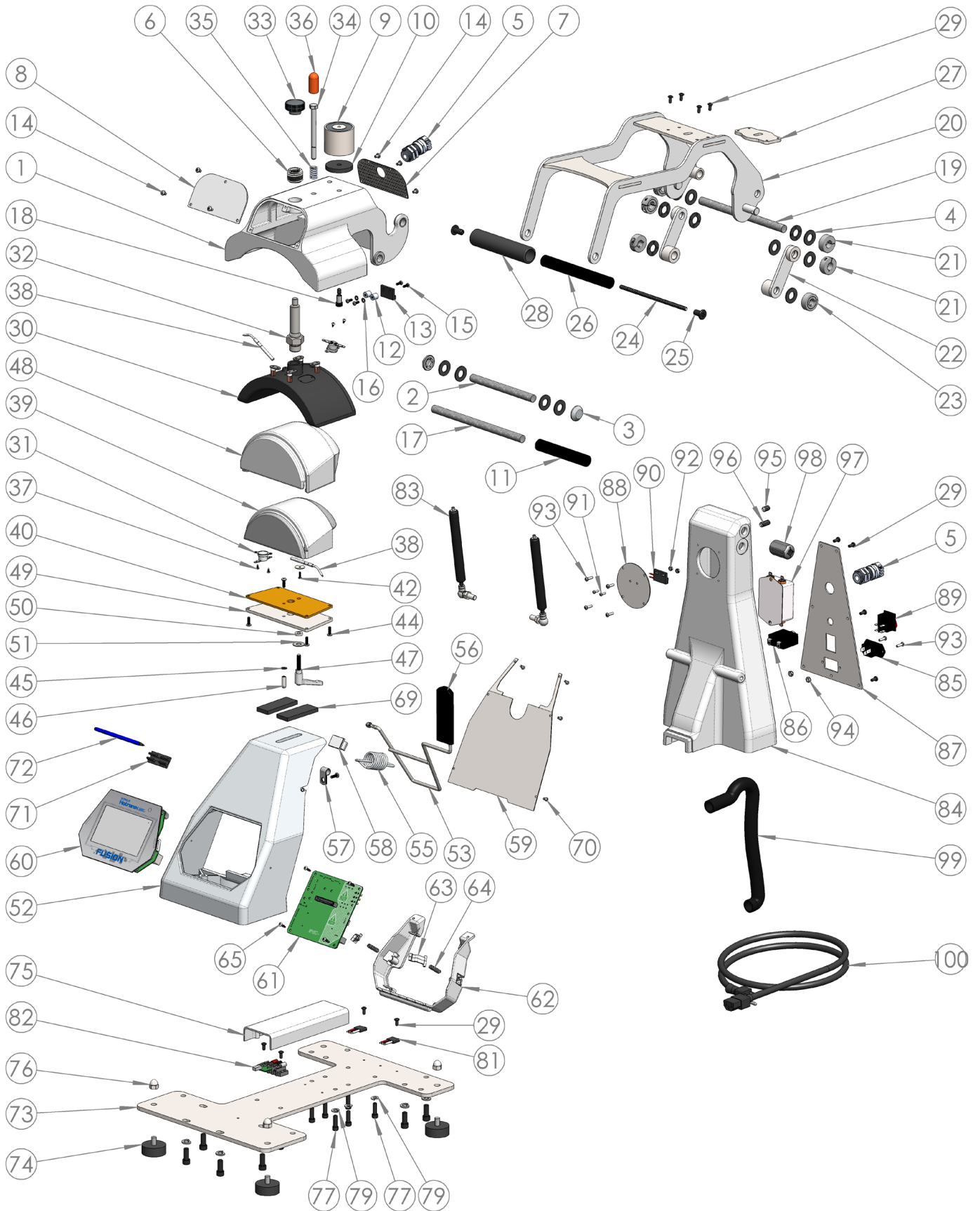

# CONTACT US

## **Stahls' Hotronix®**

One Industrial Park  
Carmichaels, PA 15320  
U.S.A.

## **Technical Support**

800.727.8520

Speak with a representative  
24 hours a day,  
7 days a week,  
365 days a year.

## **Customer Service**

800.727.8520

Monday - Friday  
8AM - 5PM EST

## **Replacement Parts**

800.727.8520

8AM - 7PM EST

## **Web**

[Hotronix.com](http://Hotronix.com)

